

IRIDEON[®] COMPOSER[™]

Remote Stations

For use with the Master Control Processor (MCP)

INSTALLATION INSTRUCTIONS

The Irideon Composer system offers six optional remote stations for use with the Master Control Processor (MCP). These stations provide access to preset looks (2RS and 8RS), programming capabilities (RS and PJ), sensor integration via the closure station (CS), and keyed access security (KS).

Recall Stations reside on a single data run and are to be wired in a daisy-chain configuration, with a 120Ω termination resistor between the two data lines (+ & -) after the last fixture. Maximum cable runs are 1000 ft.

WIRING. The following wiring requirements apply to all recall stations except Programming Jack (PJ) and Key Switch (KS).

Control

Wire Type: Belden 9841 (or equivalent), one shielded twisted pair, 24 AWG.

Nominal conductor resistance: 24Ω per 1000 ft.

Nominal shield resistance: 2.2Ω per 1000 ft.

Capacitance between conductors: 12.8pf/ft.

Capacitance between conductor & shield: 23 pf/ft.

Nominal Impedance: 120Ω.

DC Power

For installations employing conduit:

Type: Belden 8461 (or equivalent), single unshielded twisted pair, 18 AWG.

For installations not employing conduit:

Type: Belden 8790 (or equivalent), single twisted shielded pair, 18 AWG, 300V.

Fixture Address switches are located on each of the remote stations except the Programming Jack (PJ) and the Key Switch (KS). These switches must be set with unique addresses to identify to the MCP which station is sending commands. Address "00" is a self-test address and should not be chosen as a station address.

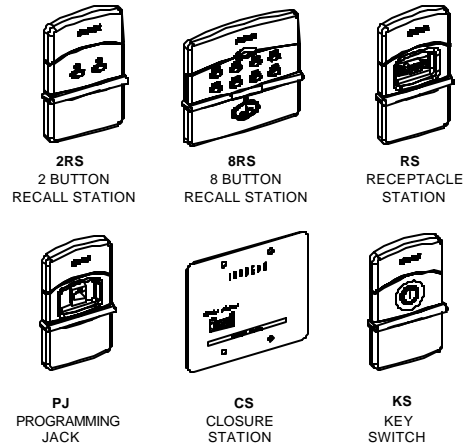

Wiring connections are made via two part plug-in terminal strips.

Data connections are made with a three pin terminal strip. Refer to the pin/wire code below.

Pin	Wire (Belden 9841)
+	Data + (White)
-	Data - (Blue)
Gnd	Drain

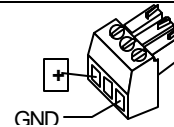

DC power utilizes a two pin terminal strip. Refer to the pin/wire code below for proper connections.

Pin	Wire (Belden 8461)	Wire (Belden 8790)
+ (24vdc)	Black	Red
- (Gnd)	White	White

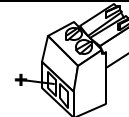

Wiring and installation methods should meet local electrical codes.

2RS 2 Button Recall Station

The two-button recall station can remotely invoke any programmed event (zone preset, zone sequence, script, zone or global command).

The 2RS is to be installed in a standard 2-1/2" deep gangable switch box (RACO #500 or equivalent). Remove the faceplate by prying gently with a small screwdriver from the bottom of the unit. Replace by first engaging the top of the faceplate and then snapping the bottom into place. The 2RS can be enabled/disabled when used in conjunction with the key switch (KS).

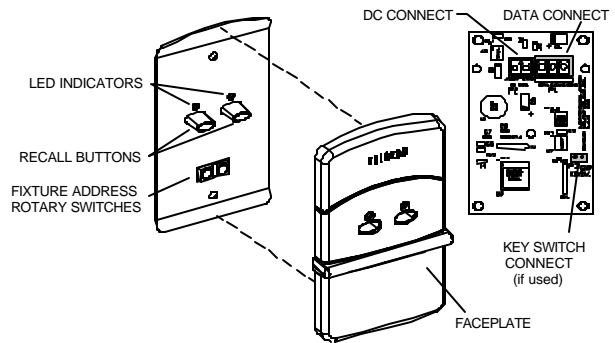

8RS 8 Button Recall Station.

The eight-button recall station can remotely invoke any programmed event (zone preset, zone sequence, script, zone or global command). The 8RS is to be installed in a 4" square by 2-1/8" deep gangable switch box (RACO #680 or equivalent). The faceplate can be lifted off the subpanel by removing two screws located behind the fold-down panel. Labels may be attached below the individual recall buttons behind the fold down panel to identify assigned presets. The 8RS can be enabled/disabled when used in conjunction with the key switch (KS).

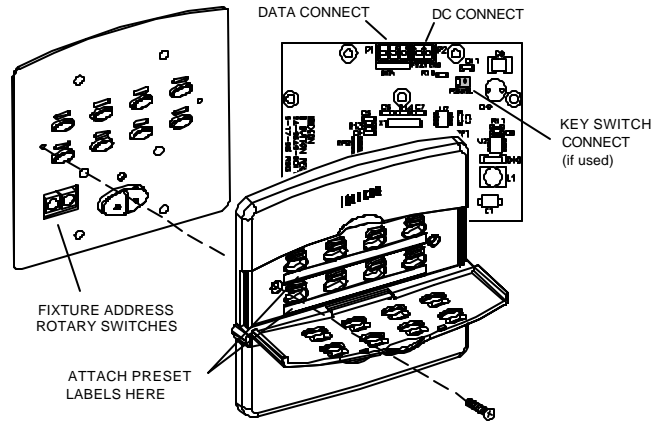

RS Receptacle Station.

The Receptacle Station features a DB9 connector to allow remote computer hookup to the Master Control Processor for system programming. The RS is to be installed in a standard 2-1/2" deep gangable switch box (RACO #500 or equivalent). Remove the faceplate by gently prying it loose with a small screwdriver from the bottom of the unit. Do not attempt to loosen the retaining lugs on the sides of the DB9 connector as these only hold the connector to the PCB.

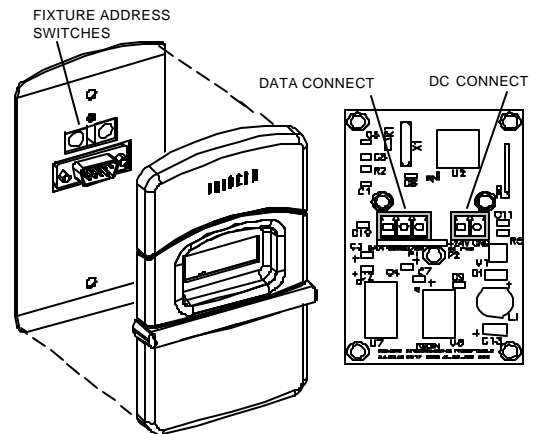

PJ Programming Jack.

The Programming Jack features an RJ45 connector allowing direct communication interface from a PC utilizing an RS232 to RS485 converter (similar to the Irideon RS485C) directly to the luminaires. This jack is a communication link for Composer PC systems in permanent installations. The PJ is to be installed in a standard 2-1/2" deep gangable switch box (RACO #500 or equivalent). Recommended wire is same as data control lines used in the other remotes. Belden 9841 (or equivalent), one shielded twisted pair, 24 AWG.

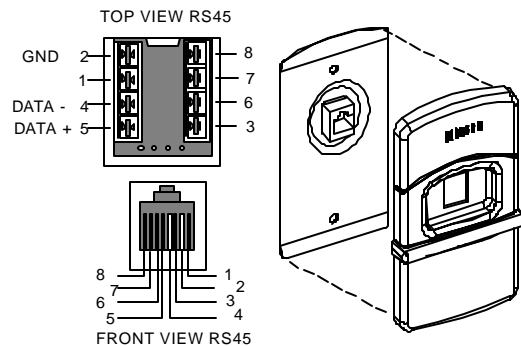

CS Closure Station.

The Closure Station provides eight programmable inputs and supports momentary or maintained contacts. The Closure Station is to be installed in a 4" square by 2-1/8" deep gangable switch box (RACO #680 or equivalent). Two part terminal strips are provided for each of the eight inputs. Output connections are provided for future applications. A metal front panel is provided with the Closure Station. Standard blank switch plate panels may be attached to the closure station if desired.

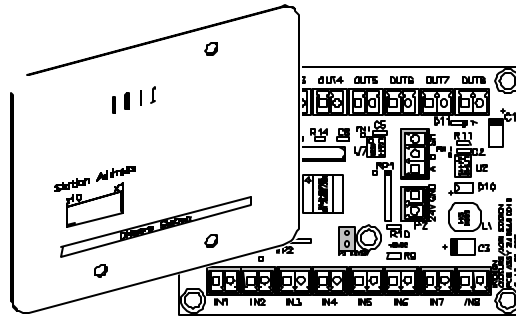

Caution: Inputs IN1 - IN8 are for dry contact switches only. Do not apply voltage to these terminals.

KS Key Switch.

The Key Switch provides local security to a single 2-button recall (2RS), 8-button recall (8RS) or Closure Station (CS). The key switch does not require power or data connections. A two pin non-polarized connector is provided on a 12" cable harness to allow convenient installation next to the recall station. The KS is to be installed in a standard 2-1/2" deep gangable switch box (RACO #500 or equivalent).

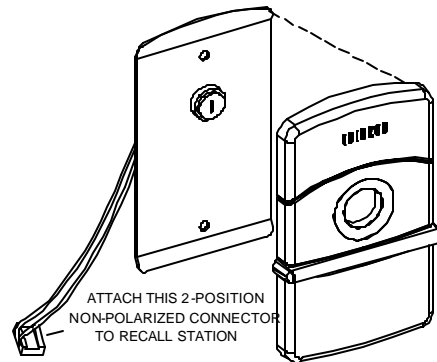

Recall Station Self Test

Self test of the recall stations require DC power to be connected. Data connection to MCP is not required, as this is a test of the remote stations internal software.

Step 1. Remove faceplate.

Step 2. Set fixture address switches to "00".

Step 3. Press one of the recall buttons and observe LED above the selected button begin to blink slowly.

Step 4. Press the same button a second time and observe the LED blinks at a faster rate.

Step 5. Press the same button a third time and observe the LED remains lit.

Step 6. Press the button a fourth and final time and observe the LED goes out. Additional presses of the button will recycle the test sequence. This test may be repeated for each of the recall buttons. Multiple buttons may be tested at the same time.

If recall station has up/down buttons (8-button recall), either button may be used to step through test sequence. Observe the LED associated with the up/down buttons during this test.

When testing is complete, return fixture address switches to their assigned address and replace faceplate.

Receptacle Station Self Test

Self test of the DB9 Receptacle Station requires DC power to be connected to the unit. Data connection to MCP is not required as this is a test of the remote stations internal software.

Step 1. Remove faceplate.

Step 2. Set fixture address switches to "00".

Step 3. Observe LED begins blinking at a constant rate.

Step 4. Return fixture address switches to their assigned address and replace faceplate.

Last Station Termination

The final recall station in the data run must be terminated with a 120Ω 1/4watt resistor across the + & - lines. This can be accomplished by inserting the resistor leads into the 2-part terminal strip along with the 24 AWG wires from the MCP as shown.

